



This manual covers the following models:

- **T805**

Thermostat Applications Guide

Description	
Gas or Oil Heat	Yes
Electric Furnace	Yes
Heat Pump (No Aux. or Emergency Heat)	Yes
Heat Pump (with Aux. or Emergency Heat)	No
Multi-stage Systems	No
Heat Only Systems	Yes
Cool Only Systems	Yes
Millivolt	Yes

Power Type

- Battery Power
- Hardwire (Common Wire)
- Hardwire (Common Wire) with Battery Backup

Table of Contents

Page

Installation Tips	2
Thermostat Quick Reference	3
Subbase Installation	4
Wiring	5
Wiring Diagrams	6
Technician Setup Menu	7-9
Mounting and Battery Installation	10
Programming The Thermostat	11-13
Specifications	14

Una versión española de este manual puede ser descargada en www.pro1iaq.com

A trained, experienced technician must install this product.

Carefully read these instructions. You could damage this product or cause a hazardous condition if you fail to follow these instructions.

Need Help?

For assistance with this product please visit <http://www.pro1iaq.com> or call Pro1 Customer Care toll-free at 888-Pro1iaq (776-1427) during normal business hours (Mon-Fri 9 AM - 6 PM Eastern)

Wall locations

The thermostat should be installed approximately 4 to 5 feet above the floor. Select an area with average temperature and good air circulation.

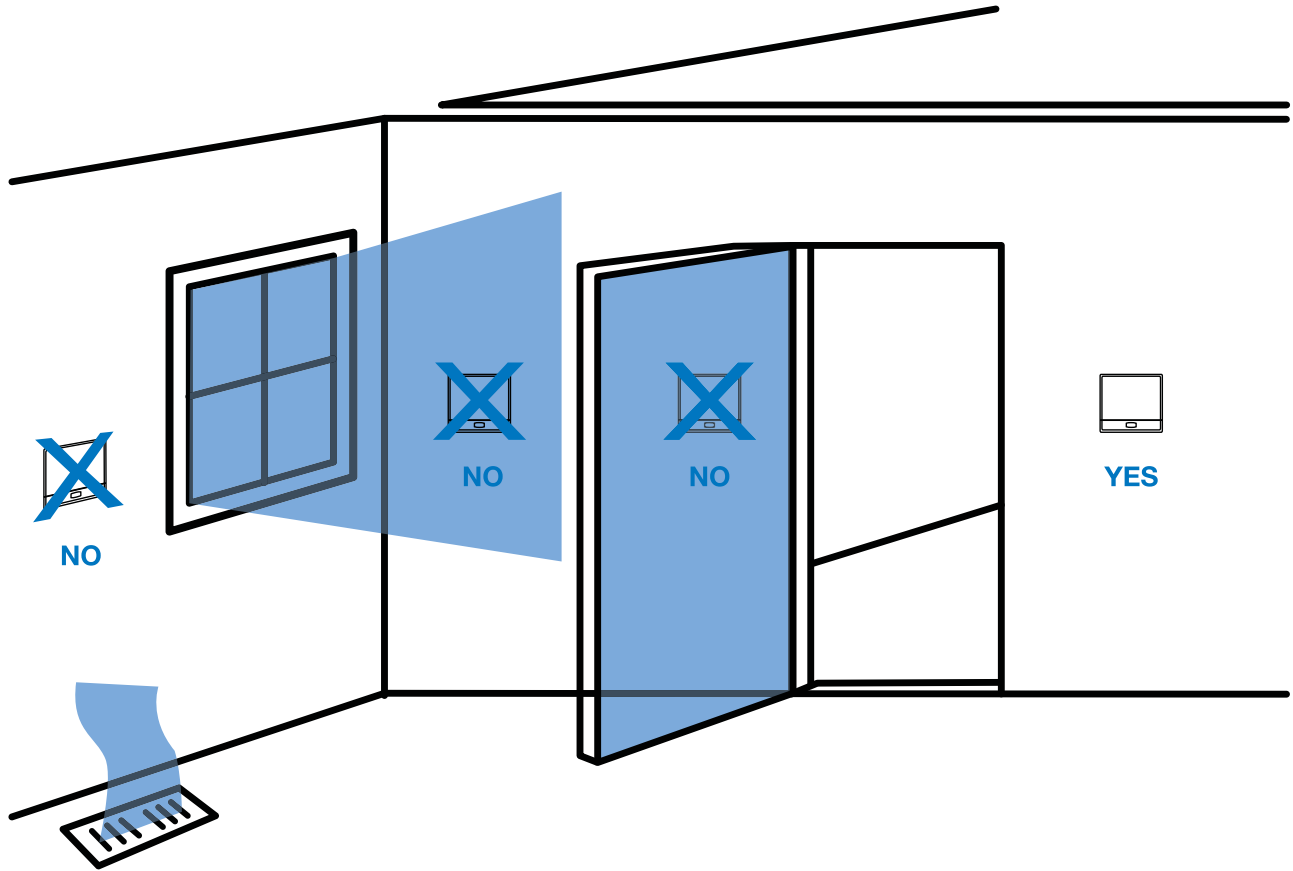

Do not install thermostat in locations:

- Close to hot or cold air ducts
- That are in direct sunlight
- With an outside wall behind the thermostat
- In areas that do not require conditioning
- Where there are dead spots or drafts (in corners or behind doors)
- Where there might be concealed chimneys or pipes

PRO1 Tip

Pick an installation location that is easy for the user to access. The temperature of the location should be representative of the building.

INSTALLATION MANUAL THERMOSTAT QUICK REFERENCE

Getting to know your thermostat

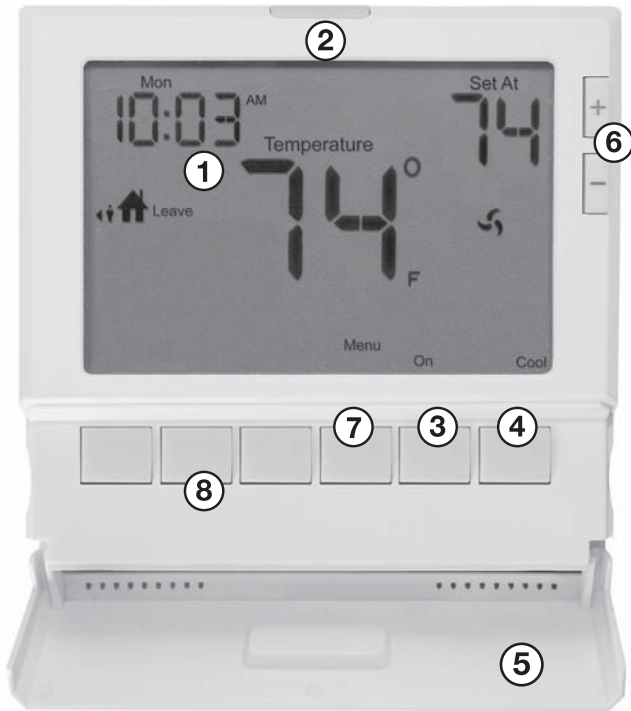

- ② Glow in the Dark Light Button
- ③ Fan Button
- ④ System Button
- ⑤ Menu Buttons Access Door
- ⑥ Temperature Setpoint Buttons
- ⑦ Menu Button
- ⑧ User Program Buttons

① LCD

Days of the week and time

Indicates the current room temperature

Displays the user selectable setpoint temperature.

Hold is displayed when thermostat program is permanently overridden.

COOL HEAT FAN
System operation indicators: The **COOL**, **HEAT** or **FAN** icon will display when the **COOL**, **HEAT** or **FAN** is on.
NOTE: The compressor delay feature is active if these icons are flashing. The compressor will not turn on until the 5 minute delay has elapsed.

Low Battery Indicator:
Replace batteries when this indicator is shown.

Program Menu Options:
Shows different options during programming.

Programmable Time Period Icons:
This thermostat has 4 programmable time periods per day.



Important:

The low battery indicator is displayed when the AA battery power is low. If the user fails to replace the battery within 21 days, the thermostat display will only show the low battery indicator as a final warning before the thermostat becomes inoperable. The batteries are located on the back of the thermostat.

Removing the private label badge



Use the bevel on lower ridge

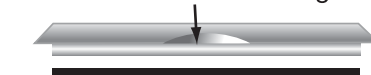

Magnet in door ↑

Gently slide a screwdriver into the bottom edge of the badge. Gently turn the screwdriver counter clockwise. The badge is held on by a magnet. The badge should pry off easily. **Do not use force.**

PRO1 Tip

All Pro1 thermostats use the same universal magnetic badge. Visit our website at www.pro1iaq.com to learn more about our free private label program.



Caution: Electrical Hazard

Failure to disconnect the power before beginning to install this product can cause electrical shock or equipment damage.



Mercury Notice:

All of Pro1's products are mercury free. However, if the product you are replacing contains mercury, dispose of it properly. Your local waste management authority can give you instructions on recycling and proper disposal.

For vertical mount put one screw top and one screw bottom.

For horizontal mount put one screw left and one screw right.

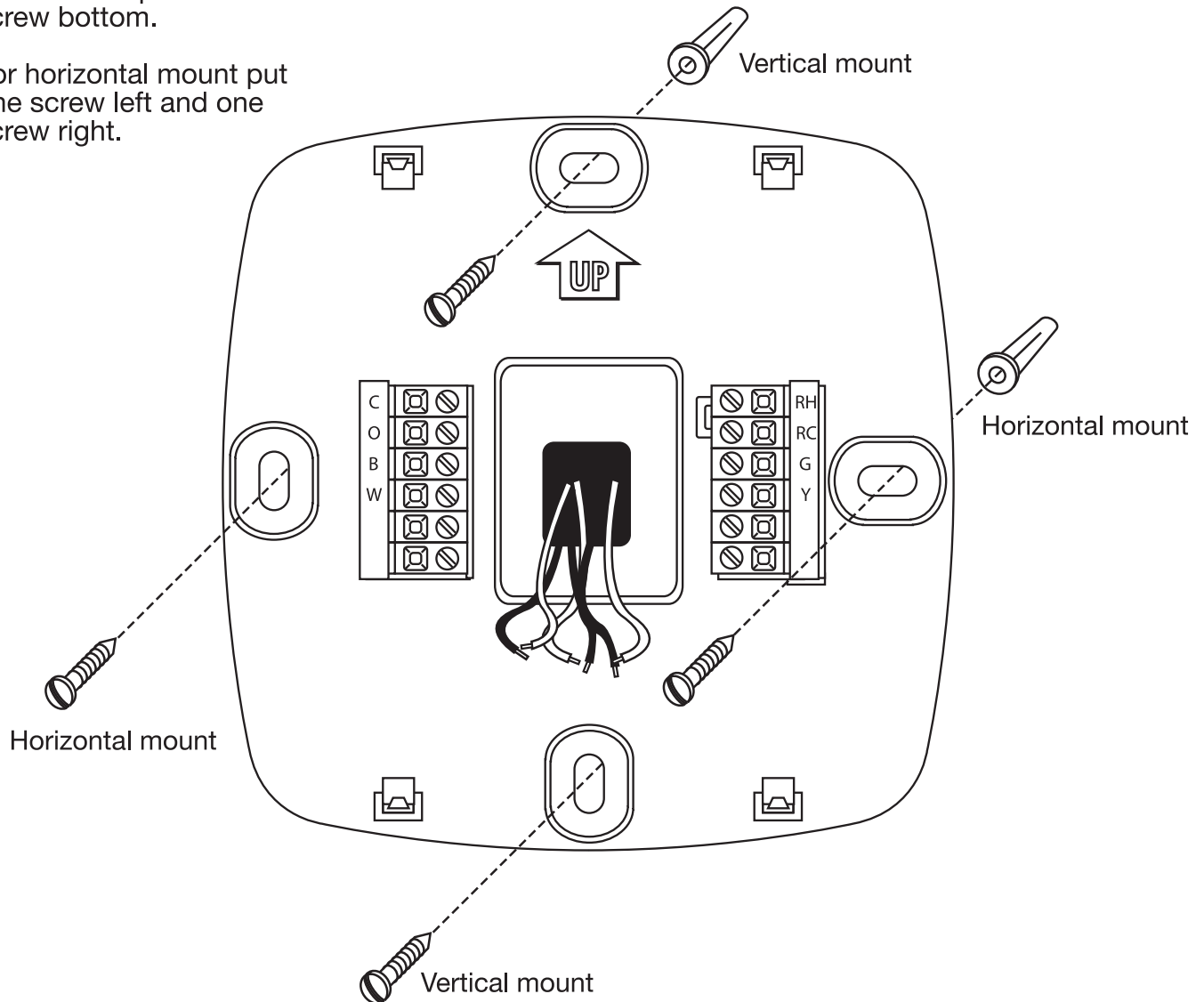



Caution: Electrical Hazard

Failure to disconnect the power before beginning to install this product can cause electrical shock or equipment damage.



Warning:

All components of the control system and the thermostat installation must conform to Class II circuits per the NEC Code.

Wiring

1. If you are replacing a thermostat, make note of the terminal connections on the thermostat that is being replaced. In some cases the wiring connections will not be color coded. For example, the green wire may not be connected to the **G** terminal.
2. Loosen the terminal block screws. Insert wires then retighten terminal block screws.
3. Place nonflammable insulation into wall opening to prevent drafts.

Terminal Designations

W Heat relay

Y Compressor relay

G Fan relay

O Heat pump changeover valve energized in cooling

RC Transformer power for cooling

RH Transformer power for heating

B Heat pump changeover valve energized in heating

C Common wire from secondary side of heating system transformer

PRO1 Tips:

RH & RC terminals

For single transformer systems, leave the jumper wire in place between RH and RC. Remove jumper wire for two transformer systems.

Heat pump systems

If wiring to a heat pump, use a small piece of wire (not supplied) to connect terminals W and Y.

C terminal

The C (common wire) terminal does not have to be connected when the thermostat is powered by batteries.

Wire specifications

Use shielded or non-shielded 18 - 22 gauge thermostat wire.

- ▲ 1 Power supply
- ▲ 2 Factory-installed jumper. Remove only when installing on 2-transformer systems.
- ▲ 3 Use either O or B terminals for changeover valve.
- ▲ 4 Use a small piece of wire (not supplied) to connect W and Y terminals.
- ▲ 5 Set fan operation switch to electric
- ▲ 6 Optional 24 VAC common connection when thermostat is used in battery power mode.

Typical 1H/1C system: 1 transformer

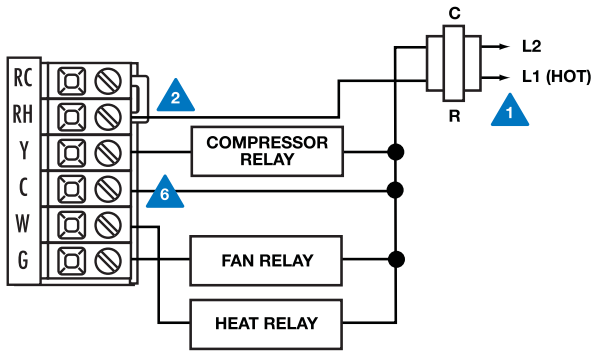

Typical 1H/1C system: 2 transformer

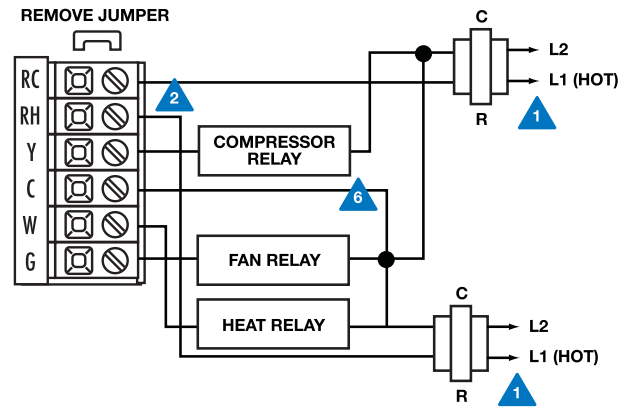

Typical 1H/1C heat pump system

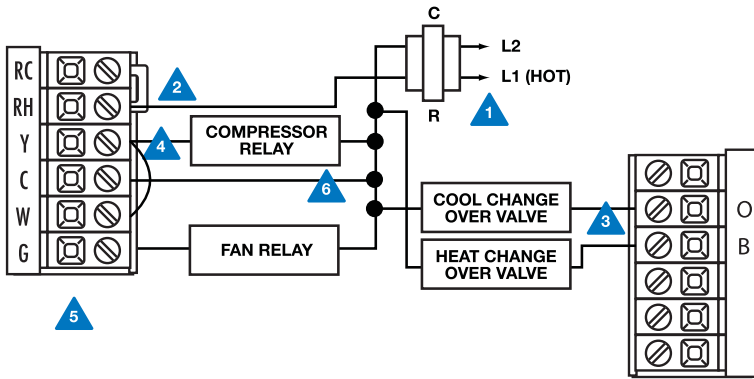

Typical heat-only system

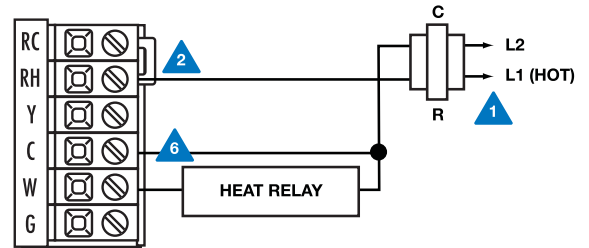

Typical heat-only system with fan

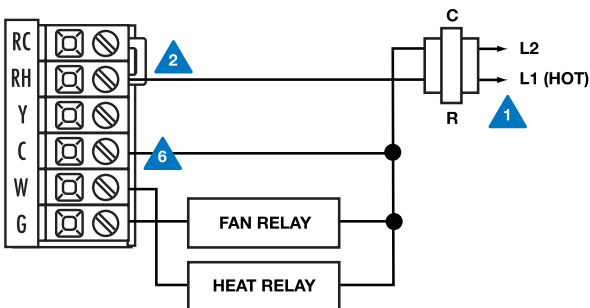

Typical cool-only system

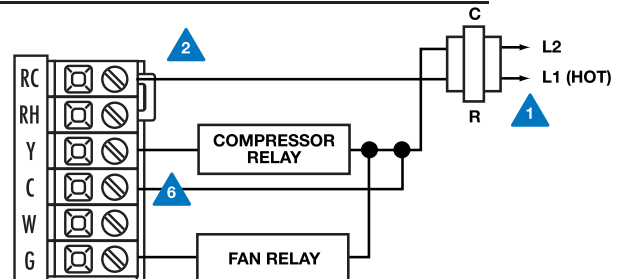











Technician Setup Menu





This thermostat has a technician setup menu for easy installer configuration. To set up the thermostat for your particular application:

1. Press **MENU** button
2. Press and hold **TECHNICIAN SETUP** button for 3 seconds. This 3 second delay is designed so that homeowners do not accidentally access the installer settings.

3. Configure the installer options as desired using the table below.

Use the  or  keys to change settings and the **NEXT STEP** or **PREV STEP** key to move from one option to another. **Note:** Only press **DONE** key when you want to exit the Technician Setup options.







Tech Setup Steps						
Filter Change Reminder	Room Temperature Calibration	Minimum Compressor On Time	Compressor Short Cycle Delay	Cooling Swing	Heating Swing	Keypad Lockout
This feature will flash FILT in the display after the elapsed run time to remind the user to change the filter. A setting of OFF will disable this feature.	This feature allows the installer to change the calibration of the room temperature display. For example, if the thermostat reads 70° and you would like it to read 72° then select +2.	This feature allows the installer to select the minimum run time for the compressor. For example, a setting of 4 will force the compressor to run for at least 4 minutes every time the compressor turns on, regardless of the room temperature.	The compressor short cycle delay protects the compressor from "short cycling". This feature will not allow the compressor to be turned on for 5 minutes after it was last turned off.	The swing setting, often called "cycle rate", "differential" or "anticipation" is adjustable. A smaller swing setting will cause more frequent cycles and a larger swing setting will cause fewer cycles.	The swing setting, often called "cycle rate", "differential" or "anticipation" is adjustable. A smaller swing setting will cause more frequent cycles and a larger swing setting will cause fewer cycles.	Keypad lockout allows you to configure the thermostat so that none or some of the keys do not function.
LCD Will Show						
						
Adjustment Options						
You can adjust the filter change reminder from OFF to 2000 hours of runtime in 50 hour increments.	You can adjust the room temperature display to ready -4°F to +4°F above or below the factory calibrated reading.	You can select the minimum compressor run time from "off", "3", "4", or "5" minutes. If 3, 4, or 5 is selected, the compressor will run for at least the selected time before turning off.	Selecting ON will not allow the compressor to be turned on for 5 minutes after the last time the compressor was on. Select OFF to remove this delay.	The cooling swing setting is adjustable from ±0.2°F to ±2°F. For example: A swing setting of 0.5°F will turn the cooling on at approximately 0.5°F above the setpoint and turn the cooling off at approximately 0.5°F below the setpoint.	The heating swing setting is adjustable from ±0.2°F to ±2°F. For example: A swing setting of 0.5°F will turn the heating on at approximately 0.5°F below the setpoint and turn the heating off at approximately 0.5°F above the setpoint.	Pick PA or FU PA = partial keypad lockout, which locks all the keys except the  or  keys. FU = Full keypad lockout, which locks out all the keys. Note: Keypad lockout instructions are below.
Factory Default Settings						
OFF	0 °F	OFF	ON	0.5 °F	0.4 °F	NA

Note: To lock the keypad hold down the  and  keys for 3 seconds. You will see a lock in the display. To unlock the keypad hold down the  and  keys for 3 seconds.

TECH SETUP
STEPS CONTINUED
ON THE NEXT PAGE



Tech Setup Steps (Continued from the previous page)

Heating Temperature Setpoint Limit	Cooling Temperature Setpoint Limit	°F or °C	12 or 24 Hour Clock	Fan Operation	Morning Recovery	Program Options
This feature allows you to set a maximum heat setpoint value. The setpoint temperature cannot be raised above this value.	This feature allows you to set a minimum cool setpoint value. The setpoint temperature cannot be lowered below this value.	Select F for Fahrenheit temperature read out or select C for Celsius read out	You can select either a 12 or 24 hour clock setting.	Select GAS for systems that control the fan during a call for heat. Select ELEC to generate the fan when the fan relay is connected to the G terminal.	This feature turns your system on before the WAKE programming time to ensure the environment is at the WAKE setpoint when the WAKE time period begins. This recovery changes over time based on the previous day's experience.	You can configure this thermostat to have a 7 day program, a 5+1+1 program or nonprogrammable.
LCD Will Show						
						
Adjustment Options						
Use the + or - key to select the maximum heat setpoint.	Use the + or - key to select the minimum cool setpoint.	°F for Fahrenheit °C for Celsius	Use the + or - key to select 12 or 24 hour clock.	GAS or ELEC	Use the + or - key to turn on or off.	Use the + or - key to select 7d for 7 day, 5d for 5+1+1, or 0d for nonprogrammable.
Factory Default Settings						
90 °F	44 °F	°F	12 Hour Clock	GAS	ON	5d

TECH SETUP
STEPS CONTINUED
ON THE NEXT PAGE



PRO1 Tip

Temperature swing, sometimes called differential or cycle rate, can be customized for this individual application. For most applications choose a swing setting that is as long as possible without making the occupants uncomfortable.

Tech Setup Steps (Continued from the previous page)

Display Light	Contractor Call Number	Beep	System Switch
<p>The display light can be configured to come on when any key is pressed or only when the light key is pressed.</p>	<p>Allows you to put your phone number in the display.</p> <p>You can choose ON or OFF</p>	<p>When any key is pressed an audible beep will sound. There is an ON or an OFF.</p>	<p>You can configure the system switch for the particular application: Heat - Off - Cool, Heat - Off, Cool - Off, Heat - Off - Cool - Auto</p>
LCD Will Show			
Adjustment Options			
<p>OFF configures display light to come on only with the light key, which will save battery power.</p> <p>ON configures the display light to come on when any key is pressed.</p>		<p>If ON is selected the beep will sound. If OFF is selected, there is no sound.</p>	
Factory Default Settings			
ON	OFF	ON	Heat - Off - Cool

INSTALLATION MANUAL

MOUNT THERMOSTAT & BATTERY INSTALLATION

Mount Thermostat

Align the 4 tabs on the subbase with corresponding slots on the back of the thermostat, then push gently until the thermostat snaps in place.



Battery Installation

Battery installation is optional if thermostat is hardwired (C terminal connected).

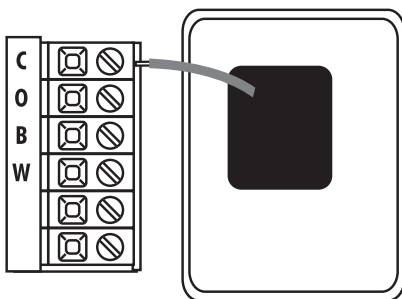

On the back of the thermostat insert 2 AA Alkaline batteries (included).

Set Time













Follow the steps below to set the day of the week and current time:

1. Press **MENU**
2. Press **SET TIME**
3. Day of the week will be flashing. Use the or key to select the current day of the week.
4. Press **NEXT STEP**
5. The current hour is flashing. Use the or key to select the current hour. When using 12-hour time, make sure the correct a.m. or p.m. choice is selected.
6. Press **NEXT STEP**
7. Minutes are now flashing. Use the or key to select current minutes
8. Press **DONE** when completed

Programming

All programmable Pro1 thermostats are shipped with an energy saving pre-program. You can customize this default program by following the Set Program Schedule.













Your thermostat can be programmed to have each day of the week programmed uniquely (7 days), all the weekdays the same, a separate program for Saturday, and a separate program for Sunday (5+1+1), or non-programmable. This thermostat has a programmable fan feature, which allows you to run the fan continuously during any time period. There are four time periods for each program (**WAKE, LEAVE, RETURN, SLEEP**).

Factory Default Program				
Day of the Week	Events	Time	Setpoint Temperature (Heat)	Setpoint Temperature (Cool)
Weekday	Wake 	6 a.m.	70° F (21° C)	75° F (24° C)
	Leave 	8 a.m.	62° F (17° C)	83° F (28° C)
	Return 	6 p.m.	70° F (21° C)	75° F (24° C)
	Sleep 	10 p.m.	62° F (17° C)	78° F (26° C)
Saturday	Wake 	8 a.m.	70° F (21° C)	75° F (24° C)
	Leave 	10 a.m.	62° F (17° C)	83° F (28° C)
	Return 	6 p.m.	70° F (21° C)	75° F (24° C)
	Sleep 	11 p.m.	62° F (17° C)	78° F (26° C)
Sunday	Wake 	8 a.m.	70° F (21° C)	75° F (24° C)
	Leave 	10 a.m.	62° F (17° C)	83° F (28° C)
	Return 	6 p.m.	70° F (21° C)	75° F (24° C)
	Sleep 	11 p.m.	62° F (17° C)	78° F (26° C)

INSTALLATION MANUAL

PROGRAMMING THE THERMOSTAT

You can use the table below to plan your customized program schedule if using 5+1+1.

Programming Table				
Day of the Week	Events	Time	Setpoint Temperature (Heat)	Setpoint Temperature (Cool)
Weekday	Wake 			
	Leave 			
	Return 			
	Sleep 			
Saturday	Wake 			
	Leave 			
	Return 			
	Sleep 			
Sunday	Wake 			
	Leave 			
	Return 			
	Sleep 			

Set Program Schedule

To customize your 5+1+1 program schedule, follow these steps

Weekday:

1. Select **HEAT** or **COOL** using the **SYSTEM** key.
Note: You have to program heat and cool each separately.
2. Press **MENU**
3. Press **SET SCHED**. Note: Monday-Friday is displayed and the **WAKE** icon is shown. You are now programming the **WAKE** time period for the weekday setting.
4. Time is flashing. Use the or key to make your time selection for the weekday **WAKE** time period. Note: If you want the fan to run continuously during this time period, select **ON** with the **FAN** key.
5. Press **NEXT STEP**
6. The setpoint temperature is flashing. Use the or key to make your setpoint selection for the weekday **WAKE** period.
7. Press **NEXT STEP**
8. Repeat steps 4 through 7 for weekday **LEAVE** time period, for weekday **RETURN** time period, and for weekday **SLEEP** time period.

Saturday:

9. Repeat steps 4 through 7 for Saturday **WAKE** time period, for Saturday **LEAVE** time period, for Saturday **RETURN** time period, and for Saturday **SLEEP** time period.

Sunday:

10. Repeat steps 4 through 7 for Sunday **WAKE** time period, for Sunday **LEAVE** time period, for Sunday **RETURN** time period, and for Sunday **SLEEP** time period.

To customize your 7 day program schedule, follow these steps:

1. Select **HEAT** or **COOL** using the system key. You have to program heat and cool each separately.
2. Press **MENU**
3. Press **SET SCHED**
Note: Monday is displayed and the **WAKE** icon is shown. You are now programming the **WAKE** time period for the Monday setting.
4. Time is flashing. Use the or key to make your time selection for the Monday **WAKE** time period. **Note:** If you want the fan to run continuously during this time period, select **ON** with the **FAN** key.
5. Press **NEXT STEP**
6. The setpoint temperature is flashing. Use the or key to make your setpoint selection for the Monday **WAKE** period.
7. Press **NEXT STEP**
8. Repeat steps 4 thru 7 for Monday **LEAVE** time period, for Monday **RETURN** time period, and for Monday **SLEEP** time period.

Tuesday, Wednesday, Thursday, Friday, Saturday, Sunday

Repeat steps 4 thru 7 for the remaining days of the week.

A Note About Auto Changeover:

If in Auto you have the ability to switch between Auto Heat or Auto Cool by pressing the System key. This can be done once the current mode has reached its set-point. For example: if in Auto Heat, the heat setpoint must be satisfied before the thermostat will allow you to switch to Auto Cool. You can switch out of Auto by holding down the System key. To get back into Auto, you must toggle the System key to Auto.

A Note About Programmable Fan:

The programmable fan feature will run the fan continuously during any time period it is programmed to be on. This is the best way to keep the air circulated and to eliminate hot & cold spots in your building.

Specifications

The display range of temperature	41°F to 95°F (5°C to 35°C)
The control range of temperature	44°F to 90°F (7°C to 32°C)
Load rating	1 amp per terminal, 1.5 amp maximum all terminals combined
Display accuracy	± 1°F
Swing (cycle rate or differential)	Heating is adjustable from 0.2°F to 2.0°F Cooling is adjustable from 0.2°F to 2.0°F
Power source	18 to 30 VAC, NEC Class II, 50/60 Hz for hardwire (common wire) Battery power from 2 AA Alkaline Energizer batteries
Operating ambient	32°F to +105°F (0° to +41°C)
Operating humidity	90% non-condensing maximum
Dimensions of thermostat	4.7"W x 4.4"H x 1.1"D

Contact Us

Pro1 IAQ Inc.

1111 S. Glenstone
Suite 2-100
Springfield, MO 65804

Toll-free: 1-888-Pro1iaq (776-1427)

Toll Number (Outside the USA): 330-821-3600

Web: <http://www.pro1iaq.com>

Hours of Operation: Monday - Friday 9 AM - 6 PM Eastern